



SmartUnit

DE: Montageanleitung

EN: Assembly Instructions



Voraussetzungen / Requirements

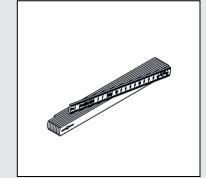
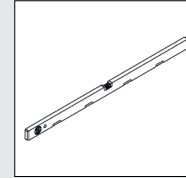
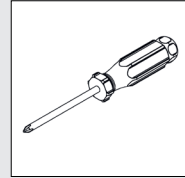
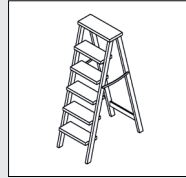
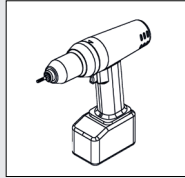
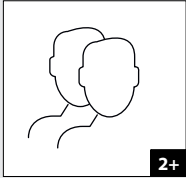

Montageset / Mounting set

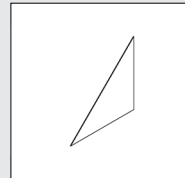
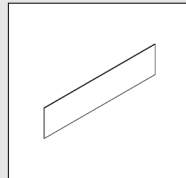
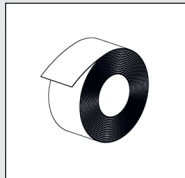
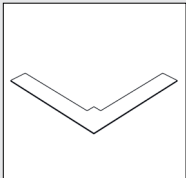
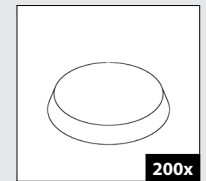
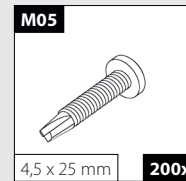
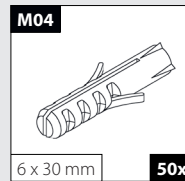
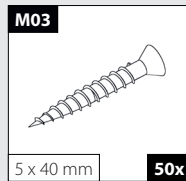
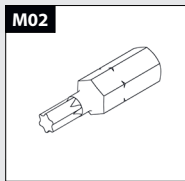
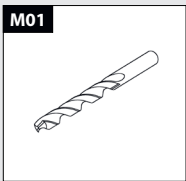

Elektrische Wandheizung / Electric wall heating

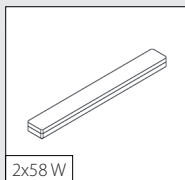
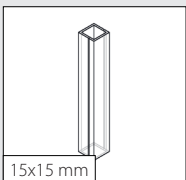
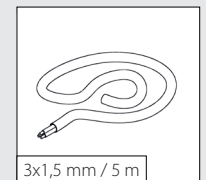
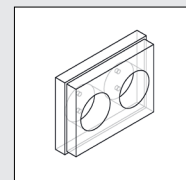
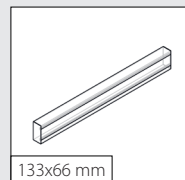
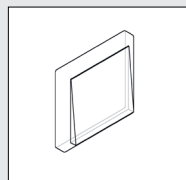
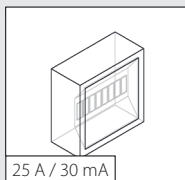
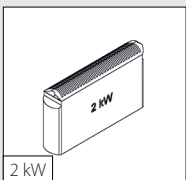



Wand-Ventilator / Wall fan



Vent-Axia G.6

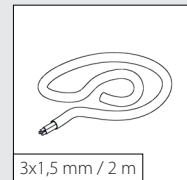
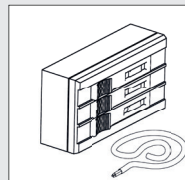
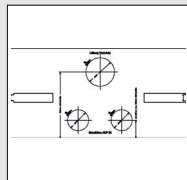
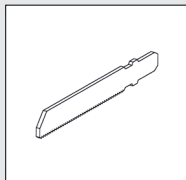

3x1,5 mm / 2 m



Klimagerät / Air conditioning

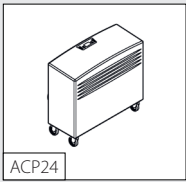

ACP24

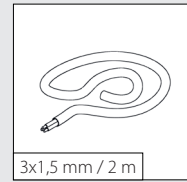
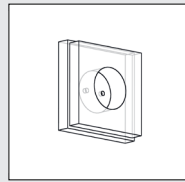
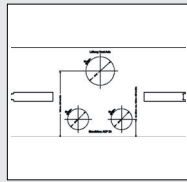
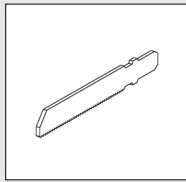

3x1,5 mm / 2 m

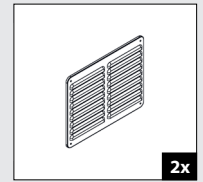

2x

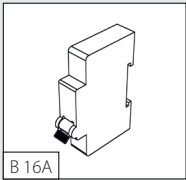

B 16A



Paneele und Profile / Panels and profiles

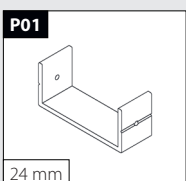
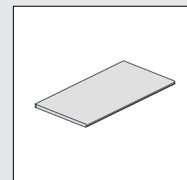
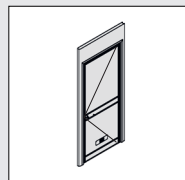
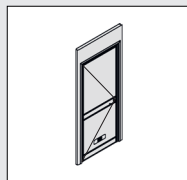
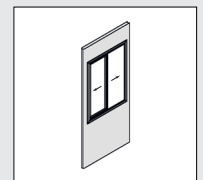
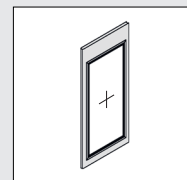
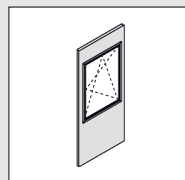
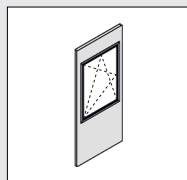
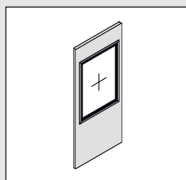
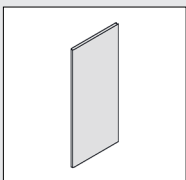

P01

24 mm

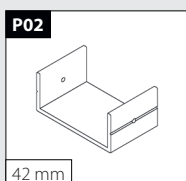

P02

42 mm



P03

558 mm

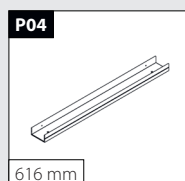

P04

616 mm

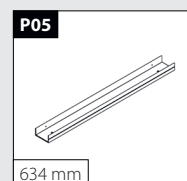

P05

634 mm



P06

1150 mm

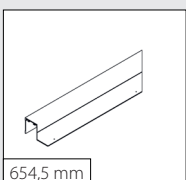

654,5 mm

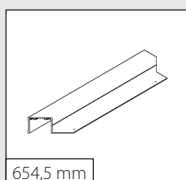

654,5 mm

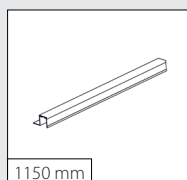

1150 mm

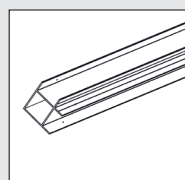

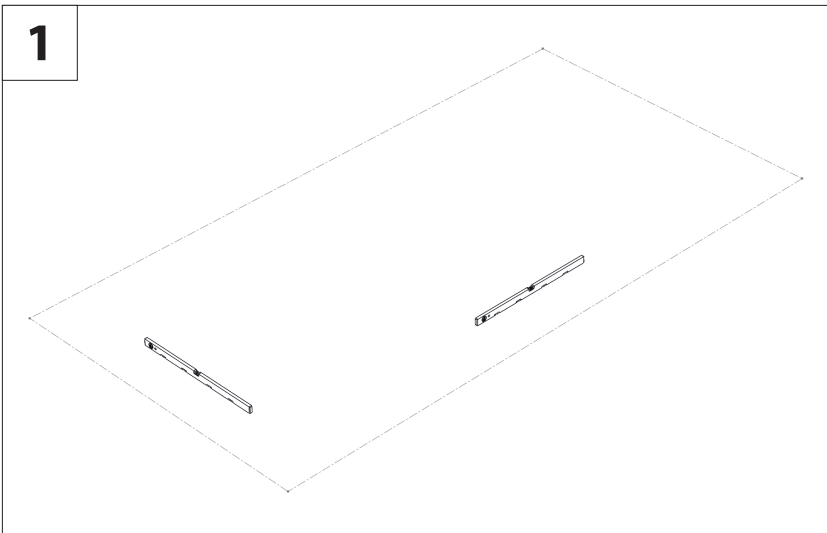
1

DE: Kontrollieren Sie die Fläche, auf der sie im nächsten Schritt die Bodenprofile anbringen, auf Ebenheit. Nutzen Sie dazu nach Möglichkeit eine Wasserwaage.

EN: Check flatness on the surface on which they will place the floor profiles in the next step. If possible, use a water balance.

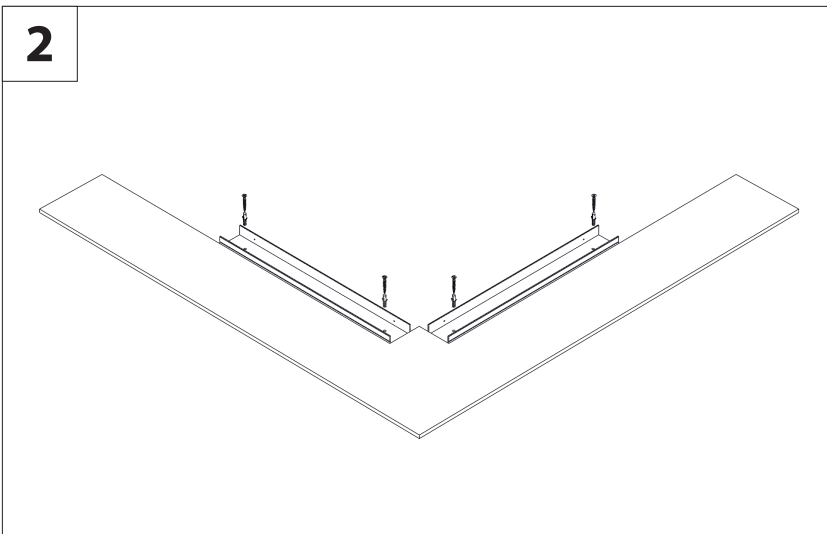
2

DE: Legen Sie die Schablone an die Außenkante der Ecke wie abgebildet an. Die Eckprofile werden nun rechtwinklig und mit optimalem Abstand ausgerichtet. Verdübeln Sie die Bodenprofile mit den mitgelieferten Dübeln und Schrauben (M03, M04). **Bei Fußbodenheizung befestigen Sie die Schienen mittels Montageklebeband am Hallenboden.**

EN: Place the stencil on the outer edge of the corner as shown. The corner profiles are now aligned at right angles and with an optimal distance. Dowel the floor profiles with the supplied dowels and screws (M03, M04). **Underfloor heating, secure the rails with mounting tape on the floor of the hall.**

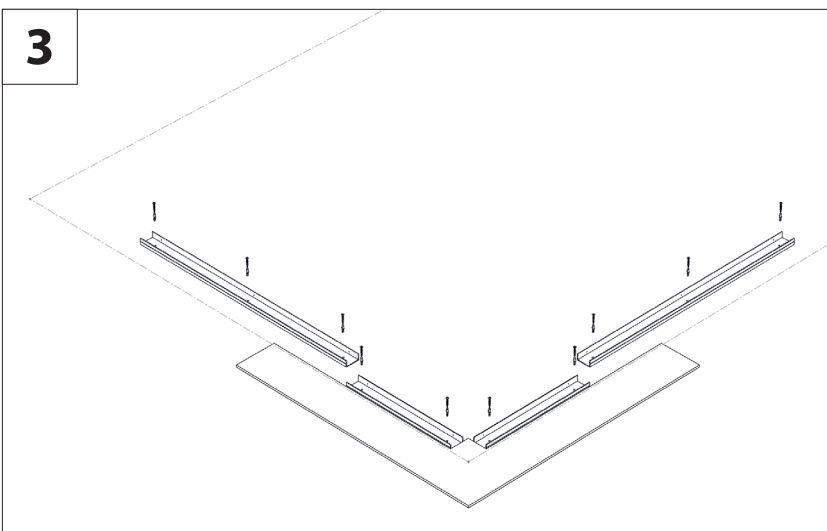
3

DE: Verdübeln Sie weitere Bodenschienen mit den mitgelieferten Dübeln und Schrauben (M03, M04). Zunächst die Seiten, an denen sich später kein Türelement befindet.

EN: Dowel further floor rails with the included dowels and screws (M03, M04). First, the sides, which are not later on a door element.

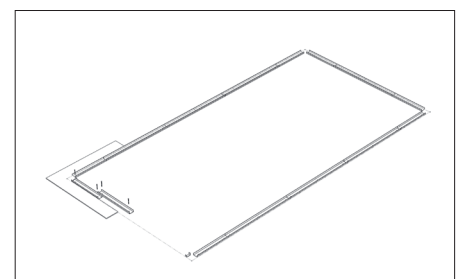
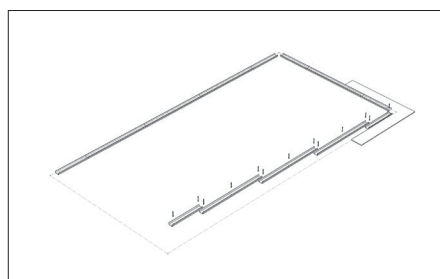
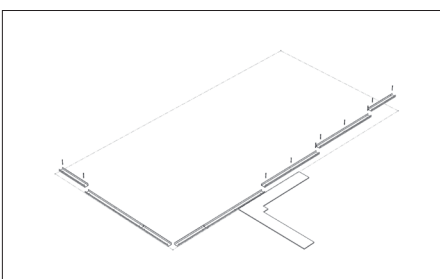

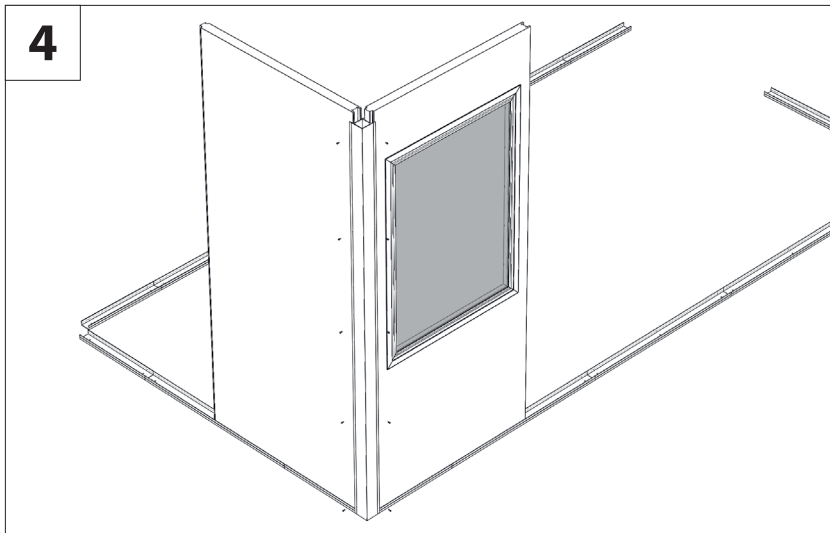

DE: Beginnen Sie bei der Montage der Wände mit der hinteren Ecke. Stecken Sie Wandelemente in die Bodenprofile wie auf der Abbildung gezeigt. Fügen Sie nun den Eckpfosten hinzu und schieben Sie die Elemente in den Pfosten, bis die Elemente, links wie rechts, fest und sicher mit Bodenprofil und Eckpfosten verbunden sind.

EN: Begin by assembling the walls with the back corner. Insert wall elements into the floor profiles as shown in the figure. Now add the corner post and slide the elements into the posts until the elements, both left and right, are securely connected to the floor profile and corner posts.

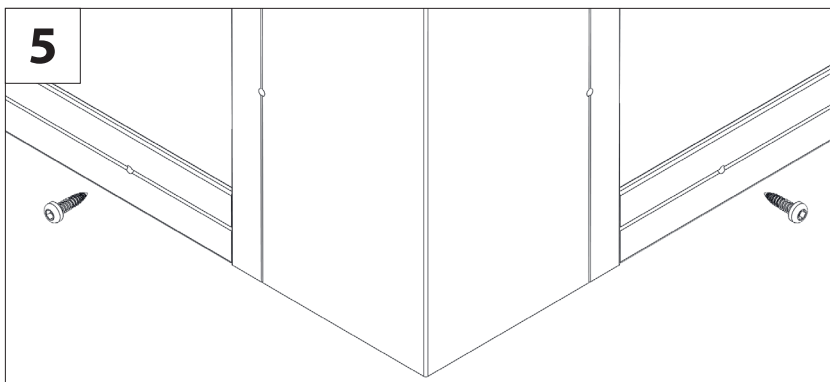

DE: Verschrauben Sie die Wandelemente mit dem Bodenprofil und dem Eckpfosten. Nutzen Sie hierfür die vorgebohrten Löcher (M05).

EN: Screw the wall elements with the floor profile and the corner post. Use the pre-drilled holes (M05).

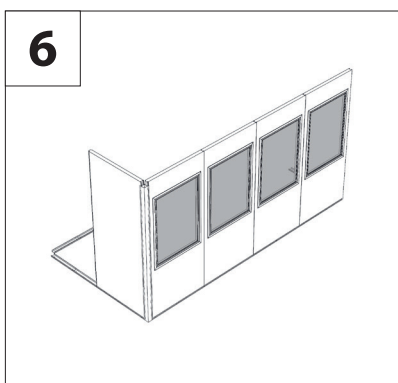
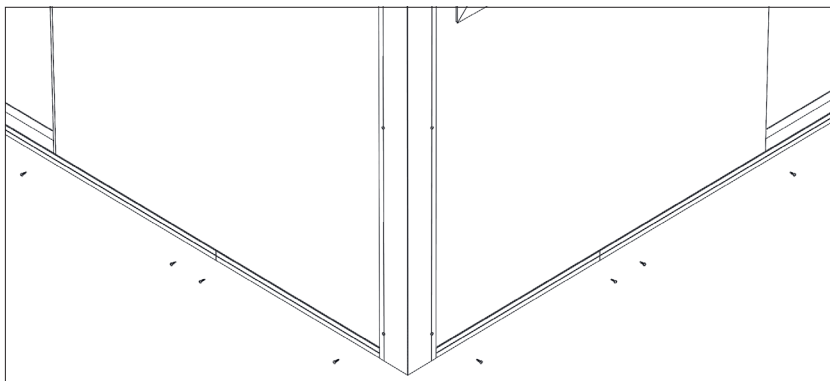

DE: Setzen Sie weitere Wandelemente ein. Stellen Sie sicher, dass die Elemente fest miteinander verbunden sind. Achten Sie auf Spalten zwischen den Elementen. Verschrauben Sie diese erst dann fest mit dem Bodenprofil (M05).

EN: Insert additional wall elements. Make sure that the elements are tightly connected. Look for columns between the elements. Then screw them tightly together with the floor profile (M05).

7

DE: Montage der Tür - Möglichkeit 1

EN: Installation of the door - possibility 1

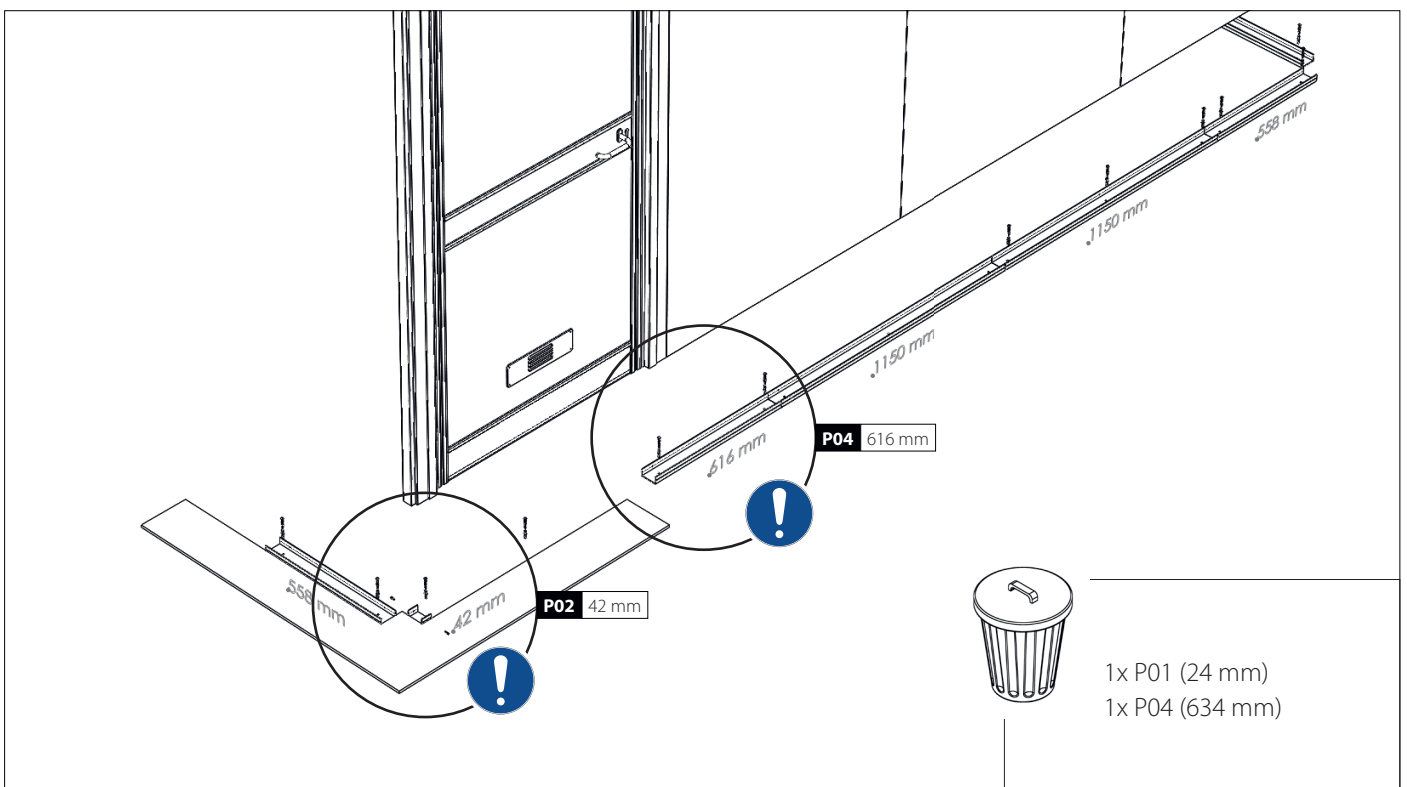
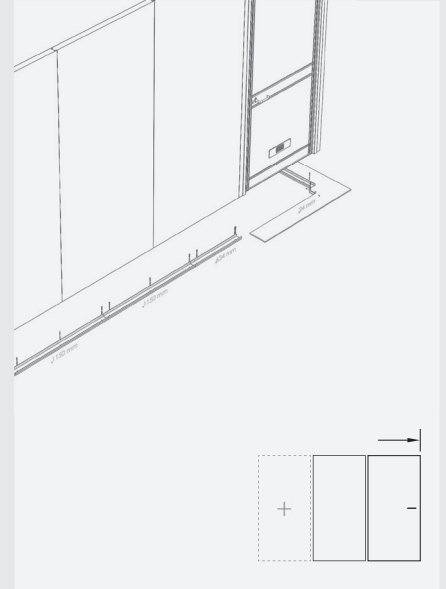
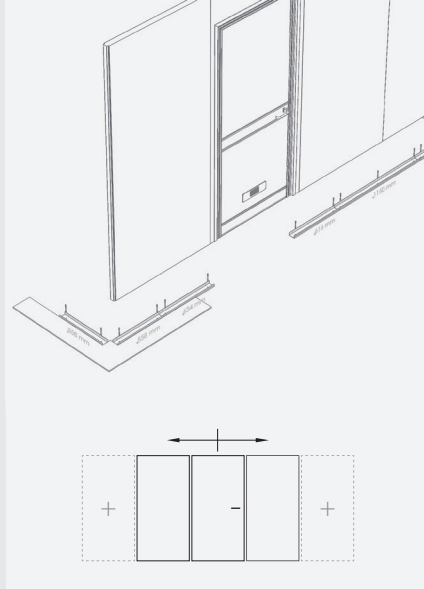
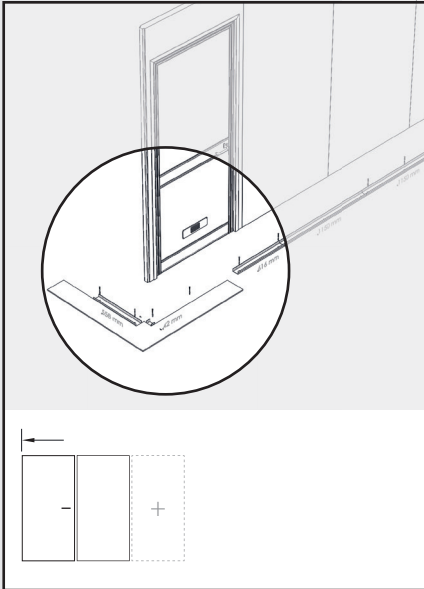

7

DE: Montage der Tür - Möglichkeit 2

EN: Installation of the door - possibility 2

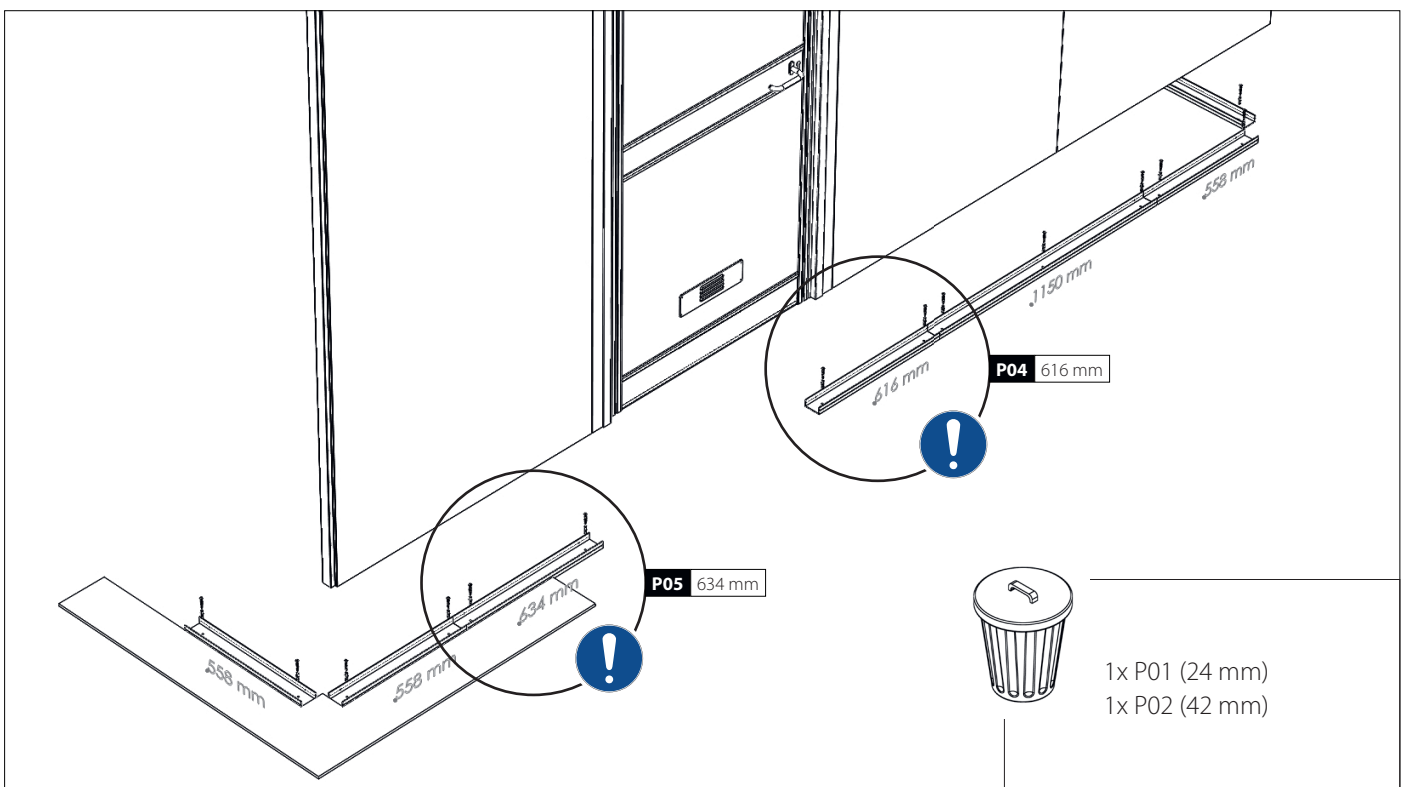
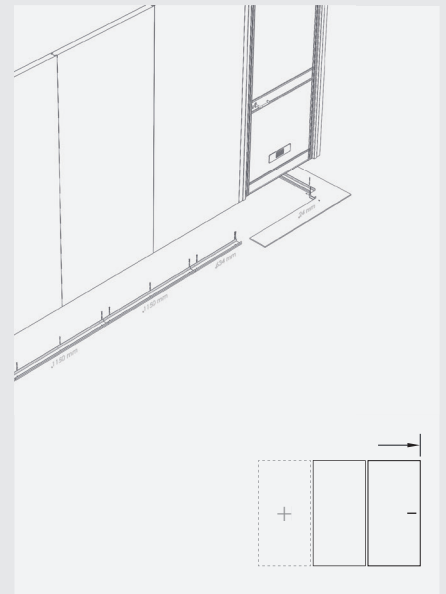
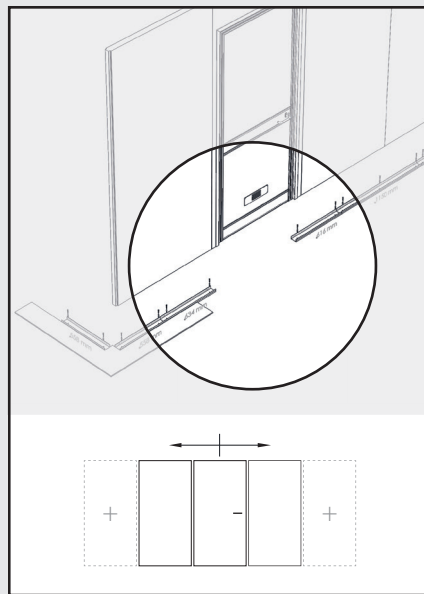
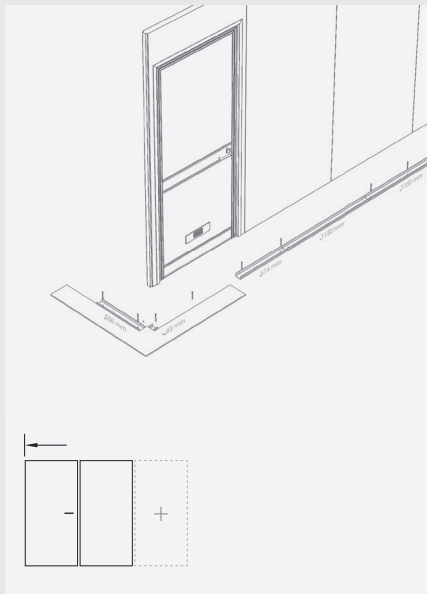

7

DE: Montage der Tür - Möglichkeit 3

EN: Installation of the door - possibility 3

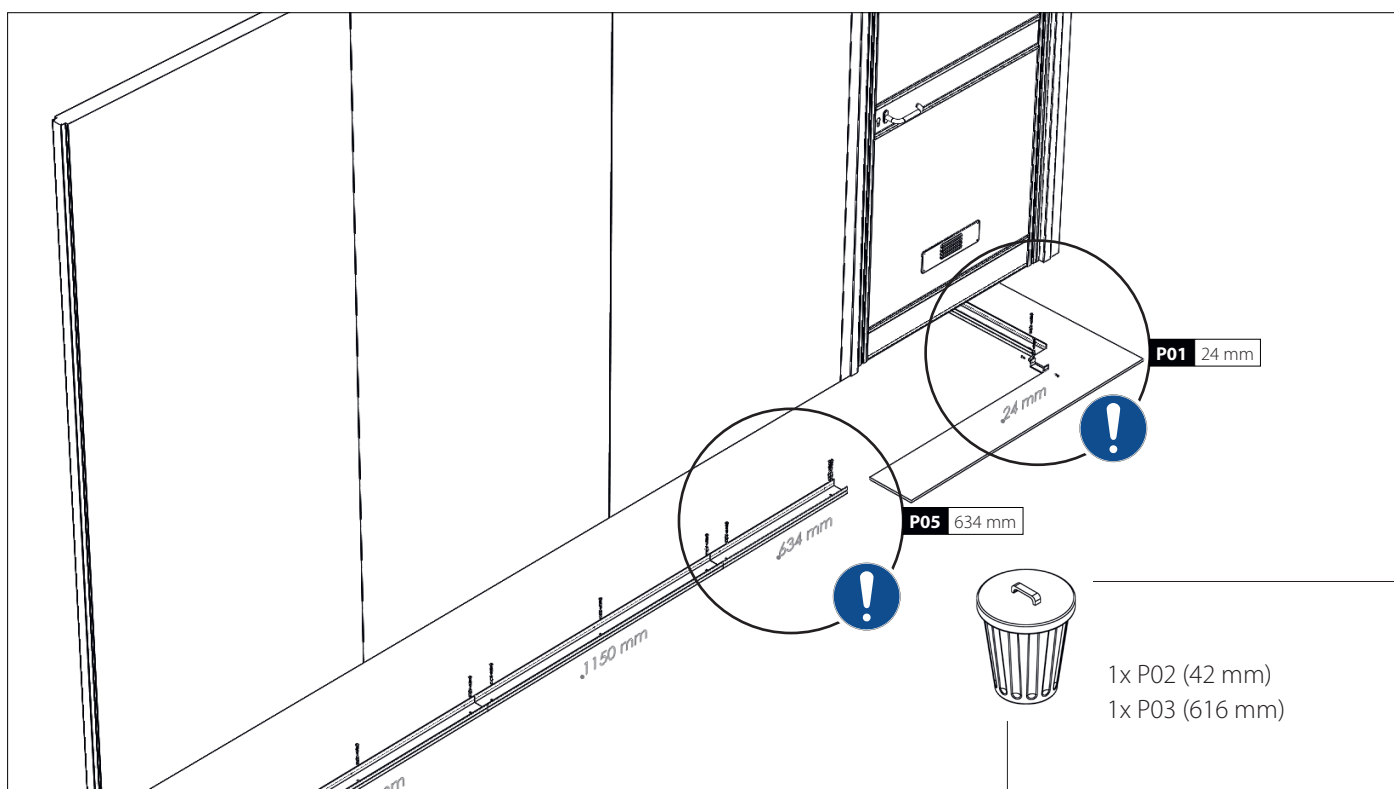
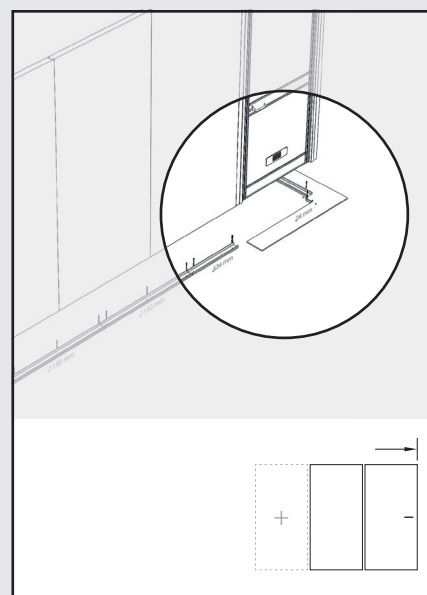
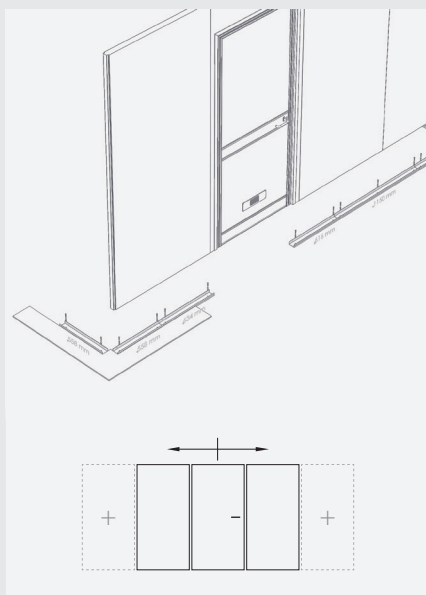
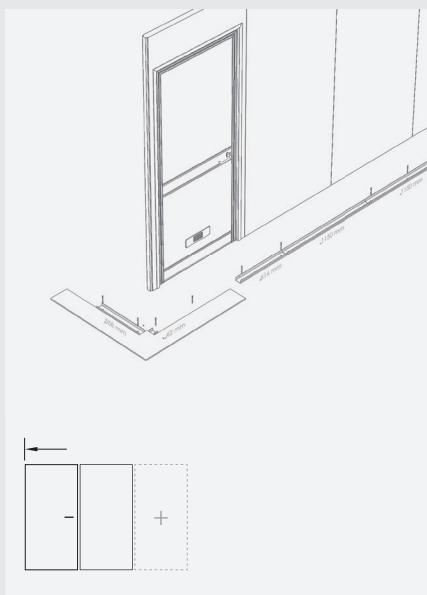

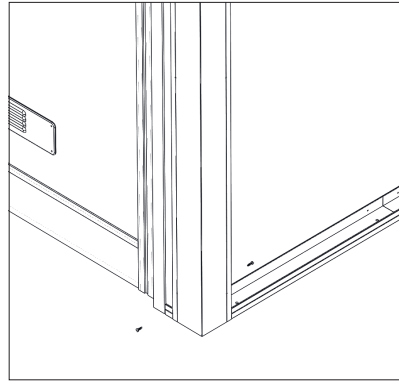
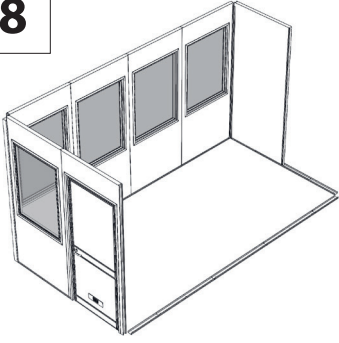
8

DE: Bringen Sie nun die Tür in Position. Das Türelement muss genau auf dem kleinen Bodenprofil liegen. Verschrauben Sie das Türelement mit dem Bodenprofilrahmen (M05).

EN: Now place the door in position. The door element must be exactly on the small floor profile. Screw the door element into the floor profile frame (M05).

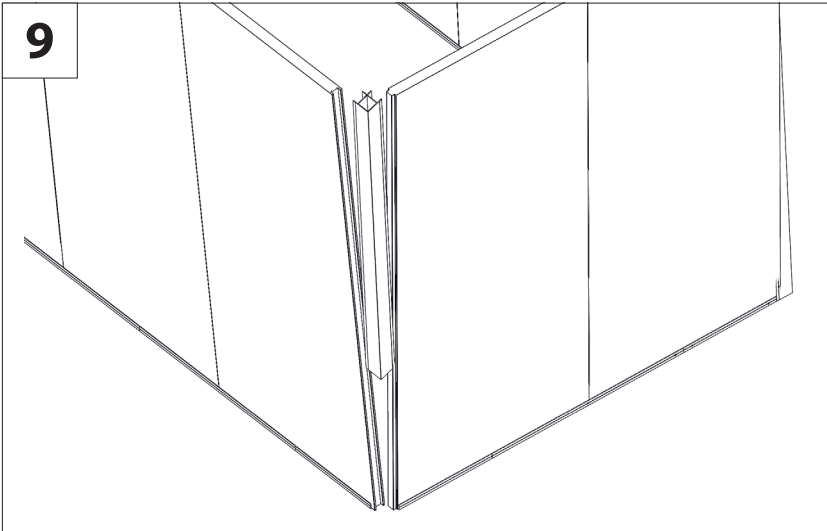
9

DE: Setzen Sie die restlichen Wandelemente ein. Um den letzten Pfosten einzusetzen, ziehen Sie die Eckelemente leicht nach außen. Setzen Sie den Pfosten schräg von oben ein und lassen ihn vorsichtig ab. Achten Sie darauf, dass der Pfosten sich mit den Elementen verbindet. Verschrauben Sie den Eckpfosten mit den Elementen.

EN: Insert the remaining wall elements. To insert the last post, pull the corner elements slightly outwards. Insert the post obliquely from above and allow it to be carefully removed. Make sure that the post joins the elements. Screw the corner post with the elements.

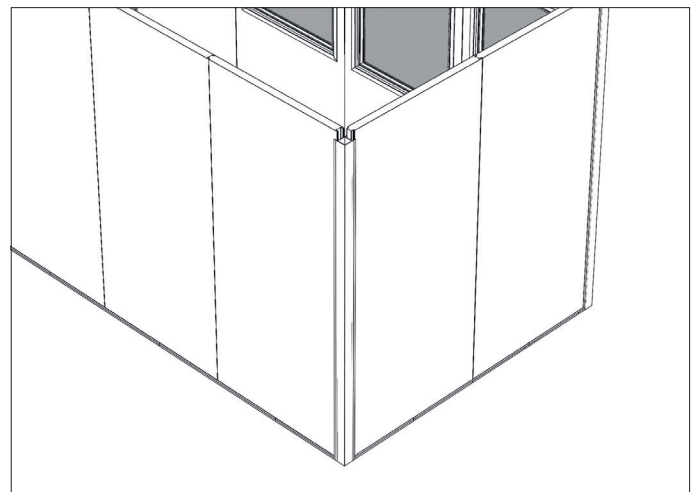
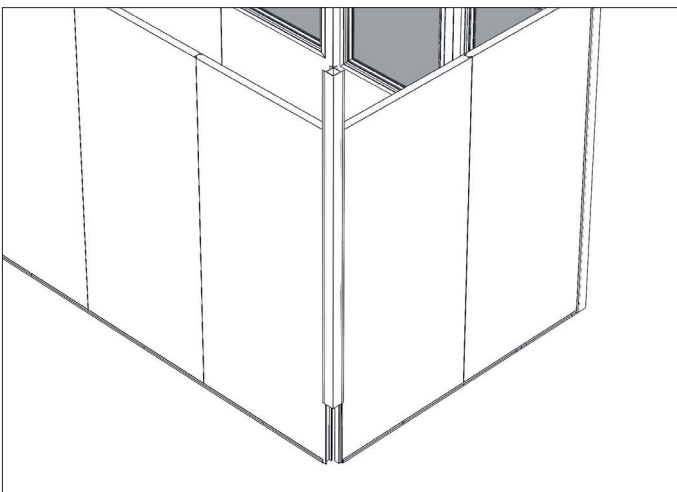
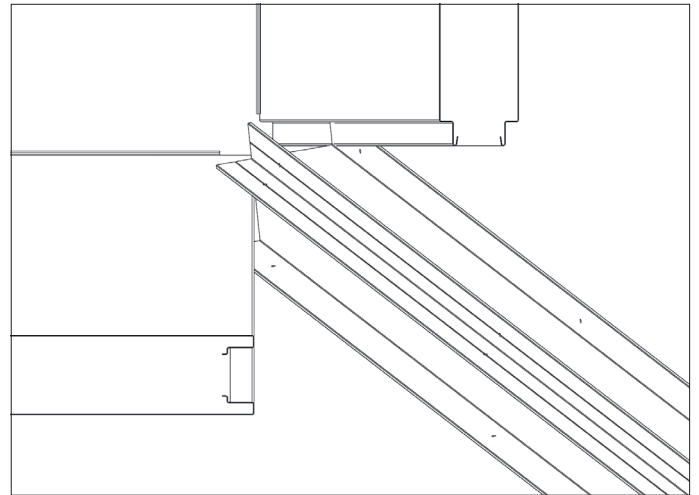
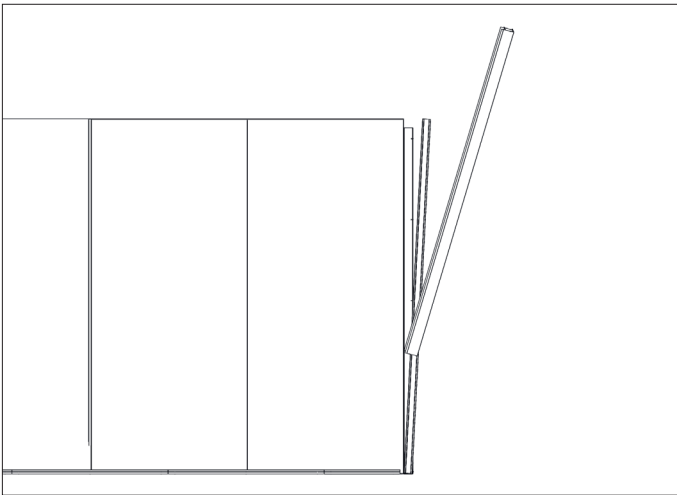

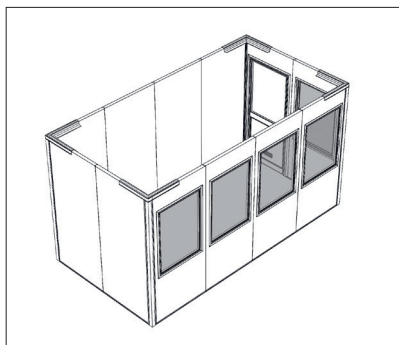
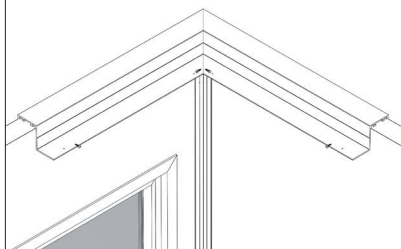
10

DE: Leitern benötigt. Für den Dachaufbau beginnen Sie mit den Eckprofilen. Verschrauben Sie diese mit den Wandelementen. Nutzen Sie hierfür die vorgebohrten Löcher. Legen Sie anschließend die restlichen Dachprofile rundherum auf die Wandelemente aus. Verschrauben Sie nun auch diese (M05).

EN: Conductors. For the roof construction, start with the corner profiles. Screw them together with the wall elements. Use the pre-drilled holes. Then lay out the remaining roof profiles around on the wall elements. Now screw these (M05).

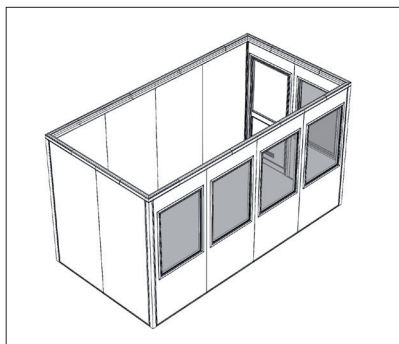
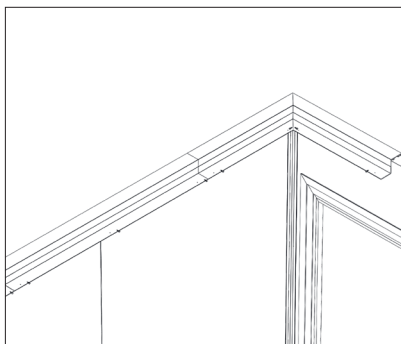
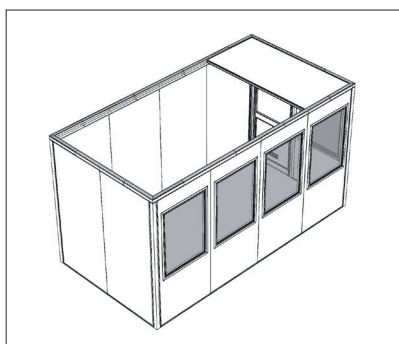
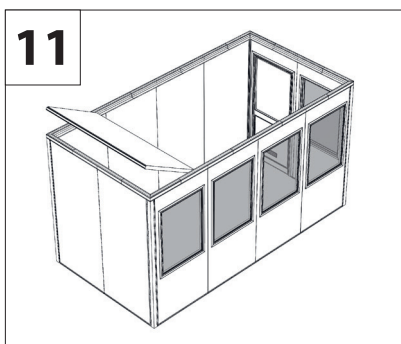
**11**

DE: Legen Sie die Dachelemente von oben auf die Schienen der Dachrahmenprofile auf. Füllen Sie das Dach durch Nachschieben weiterer Dachelemente auf.

EN: Lay the roofing elements from above onto the rails of the roof frame profiles. Fill the roof by sliding additional roof elements.

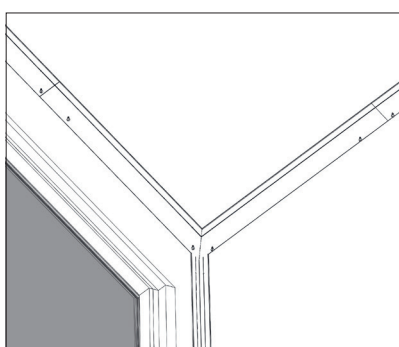
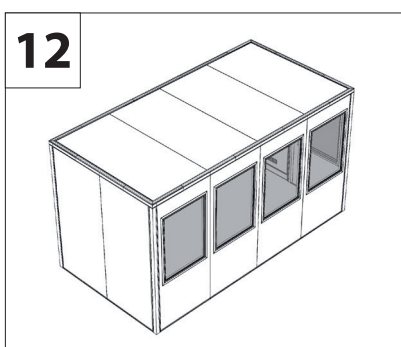
12

DE: Kontrollieren Sie, ob die Dachelemente sauber auf den Schienen der Dachrahmen aufliegen und verschrauben Sie diese miteinander (M05). Die Montage Ihrer SmartUnit ist abgeschlossen.

EN: Check that the roof elements are neat on the rails of the roof frames and screw them together (M05). The installation of your SmartUnit is complete.



DE: Das Dach der SmartUnit ist nicht belastbar!
EN: The roof of the SmartUnit is not loadable!